

**Applicable Model**

A05

**Drawing Title**

Intercom Panel

**Drawing Unit**

mm

**Drawing Scale**

Not to scale

**DRAFT  
SUBJECT TO  
CHANGE**

**Last Revised**

Jan 27, 2021

**Drawing Version**

V1.0

**Page**

1 of 3

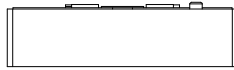

5 TOP VIEW



2 RIGHT VIEW

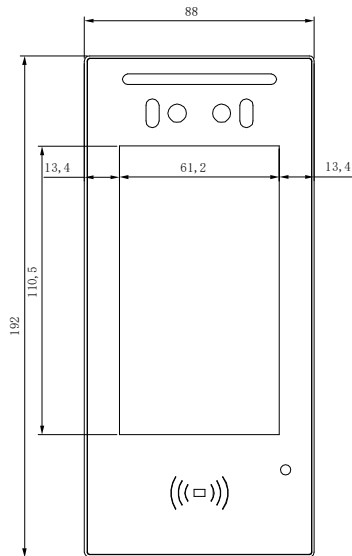

1 FRONT VIEW

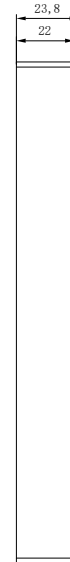

3 LEFT VIEW

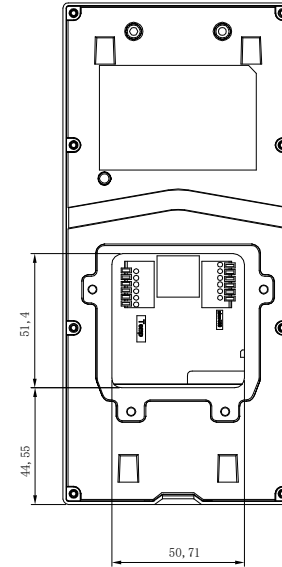

4 BACK VIEW

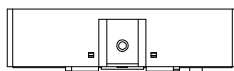

6 BOTTOM VIEW

**Applicable Model**

A05

**Drawing Title**

Wall Mounting Bracket

**Drawing Unit**

mm

**Drawing Scale**

Not to scale

**DRAFT  
SUBJECT TO  
CHANGE**

**Last Revised**

Jan 27, 2021

**Drawing Version**

V1.0

**Page**

2 of 3

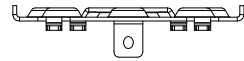

5 TOP VIEW

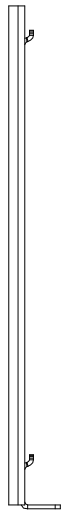

2 RIGHT VIEW

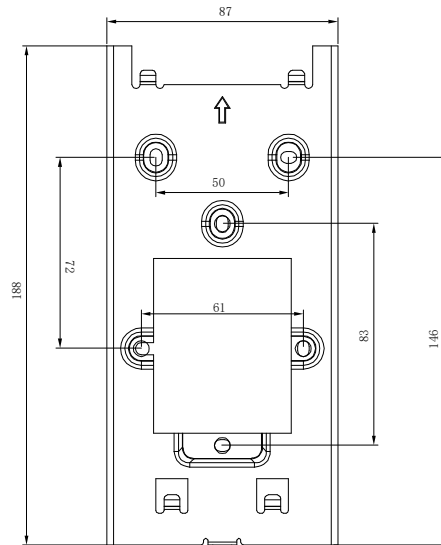

1 FRONT VIEW

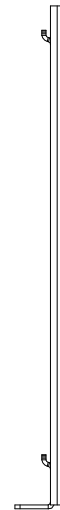

3 LEFT VIEW

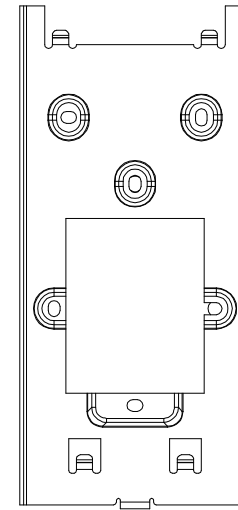

4 BACK VIEW

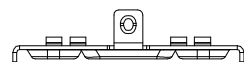

6 BOTTOM VIEW

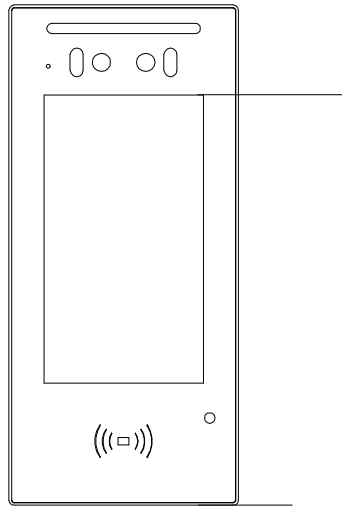

① INTERCOM PANEL FRONT VIEW

1040mm TO BOTTOM OF PANEL

1200mm MAX TO TOP OF USABLE TOUCHSCREEN

ADA Compliance Requirement

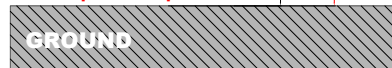

GROUND

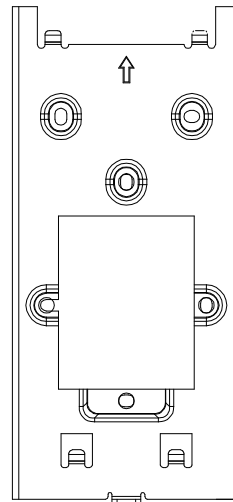

② FRONT VIEW:WALL MOUNTING BRACKET PLACEMENT

1040mm TO BOTTOM OF BRACKET

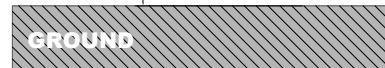

GROUND

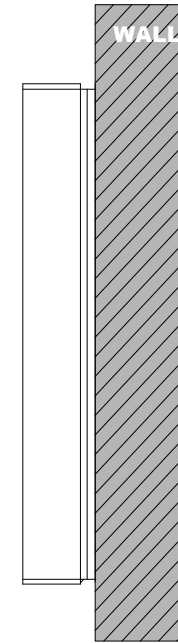

③ SIDE VIEW:INTERCOM ON WALL